



Comparison between Seismic Response of CSPSW and SPSW to Nonlinear Excitations

Mahdi Chavoshi ^{1*}, Ramin Ketabforush Badri ²

^{*1} M.Sc. student, University of Bonab, Bonab, Iran

(m.ch.civil.eng@gmail.com)

² Assistant professor, Department of Civil Engineering, Azarshahr Branch, Islamic Azad University, Azarshahr, Iran

(Date of received: 10/03/2020, Date of accepted: 15/05/2020)

ABSTRACT

Recently, the application of Composite Steel Plate Shear Walls (CSPSWs) and Steel Plate Shear Walls (SPSWs) as lateral load-resisting systems has been developed. These systems should be resistant enough, ductile, and stiffened to support against different types of excitations. In this work, the seismic performance of these two systems is investigated under different near- and far- field inputs. Strip elements are employed to model the CSPSW and SPSW in SAP2000. An experimental result of CSPSW is first verified. A six story building frame equipped with both systems is then modeled and six different far and near field seismic records are applied to the building frame. Nonlinear Time History Analyses (NTHAs) are conducted based on different maximum ground acceleration levels. Based on the results, appropriate seismic performance of CSPSWs can be clearly observed. CSPSW are also able to decrease relative story displacements more than SPSW. More precisely, CSPSWs experience Life Safety (LS) performance level or at least Collapse Prevention (CP) performance level while SPSWs fully collapse.

Keywords:

Composite Steel Plate Shear Walls, Steel Plate Shear Walls, seismic performance, performance level, pushover analysis.



1. Introduction

Recently, the application of Composite Steel Plate Shear Walls (CSPSW) and Steel Plate Shear Walls (SPSW) as lateral load-resisting systems has been developed. In this regard, seismic excitations like earthquakes applied on structural members threaten strength of these lateral resistant systems. These systems should be resistant enough, ductile, and stiffened to support against different types of excitations. Steel plate has main role on providing strength to SPSW. In CSPSW, concrete cover is added to one or two sides of steel plate to avoid the buckling of steel plate. The concrete panel provides out-of-plane restraint preventing premature failure of the steel plate due to buckling. Both the shear and the energy dissipating capacity of the steel plate are thus significantly improved. Moreover, the concrete panel acts also as fire proof for the steel plate. Zhao and Astaneh-Asl(2004) [1] improved the detailing of CSPSW by leaving gaps between the concrete panel and boundary members such that the lateral force is resisted only by the steel plate, protecting the concrete panel from cracking or crushing under lateral force. In this way, the protection of the concrete panel on the steel plate will not decrease during seismic actions. Figure 1 shows main components of CSPSW.

2. Mechanism of SPW and CSPW

Thin SPSWs buckle under very low compressive stress and hence resist lateral force by means of diagonal tensile action. In the case of CSPSW, the steel plate will develop pure shear stress if the out-of-plane restraint provided by the concrete panel is ideal and sufficient. However, according to experimental results by Tsai et al. (2006) [2] and Gao (2007) [3], the steel plates in CSPSW exhibited diagonal tensile action similar to that of thin SPSWs, as shown in Figure 2, in which residual deformation of the steel plates can be seen in diagonal directions. This is due to the gaps between the concrete panel and the boundary members, where the steel plates do not have out-of-plane restraint. Thus the diagonal residual deformations occurred in this region. Based upon the similarity between the mechanisms of the CSPSW and the SPSW, the strip model (Thorburn et al. 1983 [4] and Driver et al. 1998 [5]) suitable for the latter case will be extended to the former one.

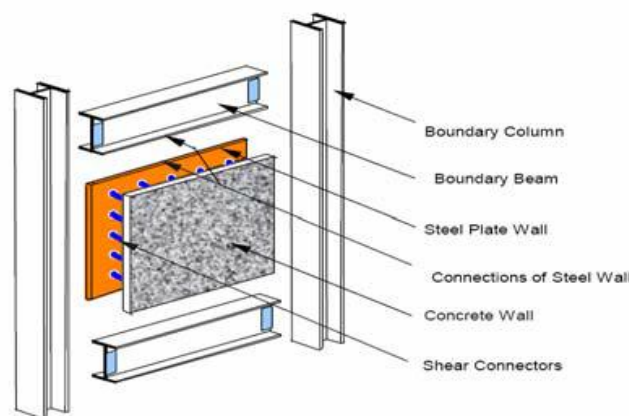

Figure 1. Main components of composite shear wall (Zhao and Astaneh-Asl, 2004) [1].

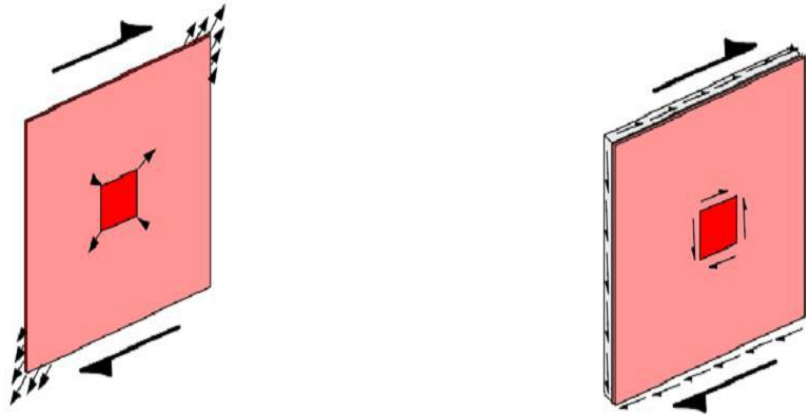

Figure 2. Stress status in thin SPSW and CSPSW.

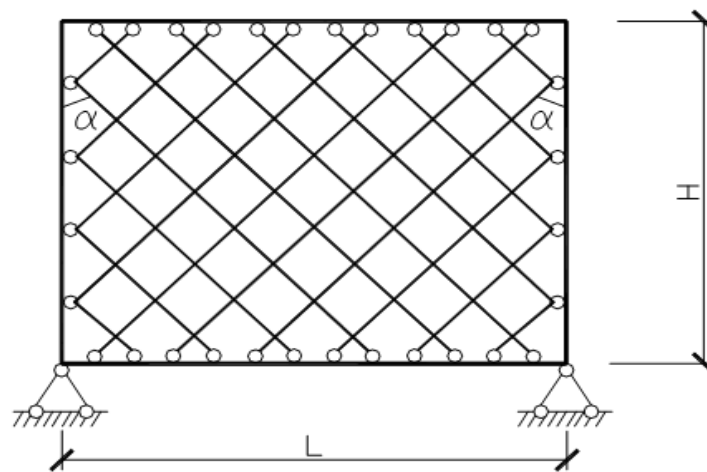

Figure 3. Modified trip model (Taherian et al. 2015) [6].

In the strip model for SPSW as shown in Figure 3, a group of parallel strips are employed to represent the tensile diagonal action, while in the compressive diagonal direction, no components are present as no significant compressive stress can exist due to buckling. In comparison, a large amount of compressive stresses will develop in the steel plate of a CSPSW resulting from the protection of the concrete panel. Thus, a second group of parallel strips in the compressive diagonal direction will be adopted for CSPSW, in addition to the tensile strips. This introduces a model named as Modified Strip Model shown in Figure 3.

3. Determination of Strip Compressive Strength

In the strip model for SPSW, the strip is a tension-only element. When extended to the cross-strip model for CSPSW, the strips in two diagonal groups are in tension and compression respectively. In the case of monotonic loading, a tension-only element and a compression-only one can be used, while for cyclic loading case, it is better to use the same axial bar element capable of resisting both tension and compression for each strip. The yielding and ultimate tensile stress of



each strip can be simply defined as those of steel, as no interaction between the stresses in the tensile and compressive strips has been considered in the model. In this way, the compressive strength of the strips must be different from that of steel, even there is no buckling in the steel plate. This treatment may lead to errors in stress distributions in the members, but will play little effect on global behavior. In order to determine the compressive strength, we assume both the tensile and compressive behavior are elasto-plastic. Considering the kinematic and equilibrium conditions for a hinged frame with rigid boundary columns and beams filled with a CSPSW at limit state, the portion of a horizontal point load at the beam level resisted by all the tensile strips is as follows according to Berman and Bruneau (2003) [7].

$$V_T = 0.5 f_y L t \sin 2\alpha \quad (1)$$

which becomes

$$V_T = 0.5 f_y L t \quad (2)$$

With the assumption of $\alpha=45^\circ$. Similarly the other portion resisted by all the compressive ones is the following

$$V_C = 0.5 f_y' L t \quad (3)$$

where f_y and f_y' are tensile and compressive strength of the strips, respectively. Thus the total capacity of the above system reads

$$V = V_T + V_C \quad (4)$$

According to AISC Seismic Provisions(2005) [8], the capacity of a CSPSW can be evaluated as

$$V = 0.6 f_y L t \quad (5)$$

Comparing Eqs. (7) and (8) gives

$$f_y' = 0.2 f_y \quad (6)$$

Which means the compressive strength of the strip can be taken as 20% of the tensile one of steel.



4. Numerical Validation

In this work, strip elements (Thorburn et al, 1983) are employed to model the CSPSW and SPSW in SAP2000 as shown in figure 4. An experimental result (Gao, 2007) of CSPSW is first verified. The specimen was installed in a pin-jointed frame with span of 2480mm and height of 1300mm (Figure 4). The height, width and thickness of the steel plate was 900mm, 1800mm and 2mm, respectively.

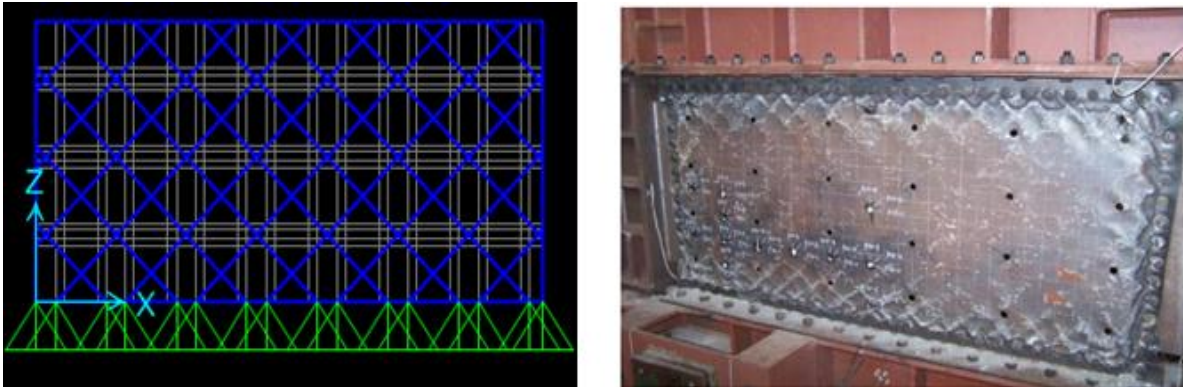

Figure 4. Model for experimental specimen with SAP2000 (Left) and Test setup (Gao, 2007) (Right)

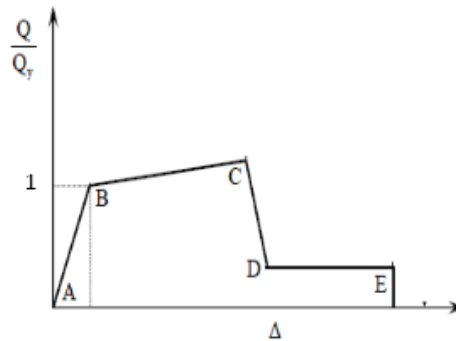

Figure 5. Bi-linear hysteretic model.

Bilinear hysteretic behavior of CSPSW and SPSW is shown in figure 5. Table 1 reports pattern behavior used to validate the model.

Table 1. Properties of CSPSW and SPSW pattern.

point	Q/Q _y		Δ
	SPSW	CPSW	
-E	0	-0.16	-14
-D	0	-0.16	-11
-C	0	-0.42	-11
-B	0	-0.2	0
A	0	0	0
B	1	1	0
C	1.22	1.22	11
D	0.8	0.8	11
E	0.8	0.8	14



Figure 6 shows the results of a pushover analysis carried on the model. Current study has a good conformity with the outcomes of hysteretic curves of experimental tests done by Gao, (2007).

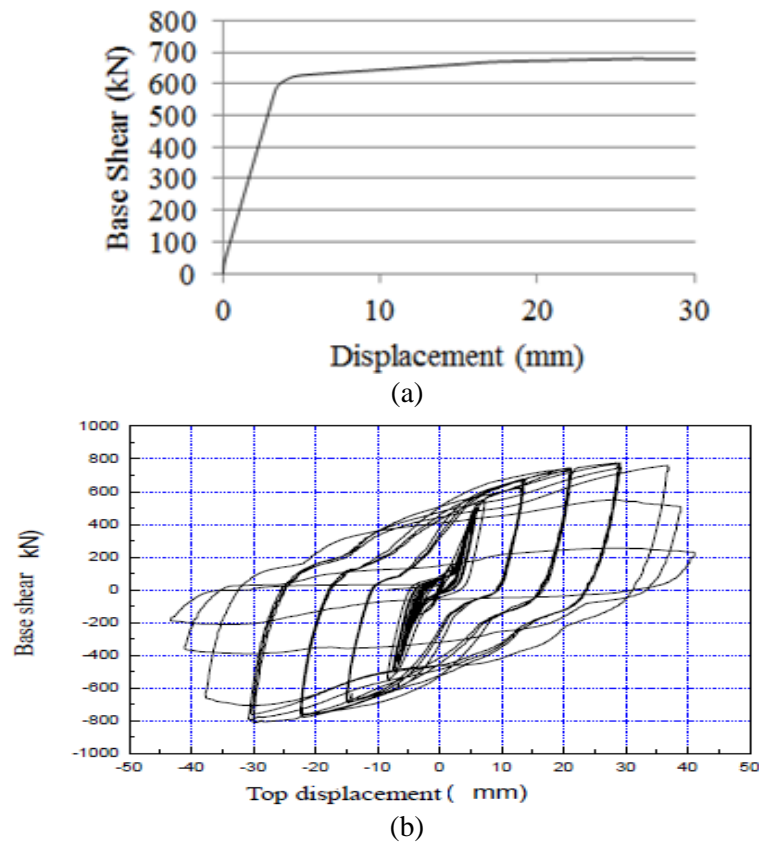

Figure 6. Validation of strip model (a) and hysteretic curves of experimental tests (Gao, 2007) (b)

Figure 7 shows a six story building frame equipped with both CSPSW and SPSW. Span length and height of stories are 5400mm and 2700mm, respectively.

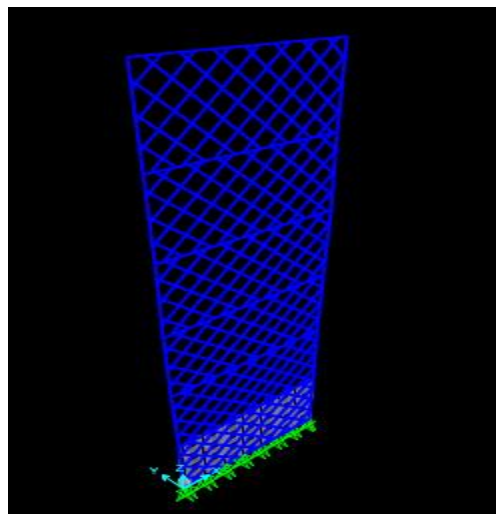

Figure 7. Six story building frame of this study.



5. Earthquake Records

Nonlinear Time History Analyses (NTHAs) are conducted based on different maximum ground acceleration levels. Table 2 presents list of records used in this study.

Table 2. Records list (<http://peer.berkeley.edu/nga>)

No	EQ	Station/Component	Distance (km)	Magnitude (M_w)	Soil Condition (USGS)	PGA (g)
1	Cape Mendocino	89530 shelter cove airport/SHL000	33.8	7.1	B	0.229
2	LANDERS	12206 Silent Valley - Poppet Flat/SIL000	51.7	7.3	A	0.05
3	NORTHRIDGE	90014 Beverly Hills - 12520 Mulhol/MU2125	20.8	6.7	B	0.444
4	MANJIL	BHRC 99999 Abbar/(NGA1633)	12.56	7.37	B	0.505
5	NORTHRIDGE	24087 Arleta - Nordhoff Fire Sta/ARL360	9.2	6.7	B	0.308
6	TABAS	9101 Tabas/TAB-LN	3	7.4	A	0.836

Figures 8 and 9, show that Immediate Occupancy (IO) performance level is reached for both systems under near field records while CSPSWs experience higher performance levels under far field records. Hence, appropriate seismic performance of CSPSWs can be clearly observed. More precisely, CSPSWs experience Life Safety (LS) performance level or at least Collapse Prevention (CP) performance level while SPSWs fully collapse.

In addition, this study deals with the effect of CSPSW on moment frame through pushover analyses. Figure 10 shows that collapse intensity in lower stories is high. Moment frame collapse intensity contribution is studied in three states including; 1) plastic CSPSWs only, 2) plastic CSPSWs and beams and 3) plastic CSPSWs, beams and columns. It is seen that CSPSW damage decreases with contribution of beams and then columns in nonlinear behavior.

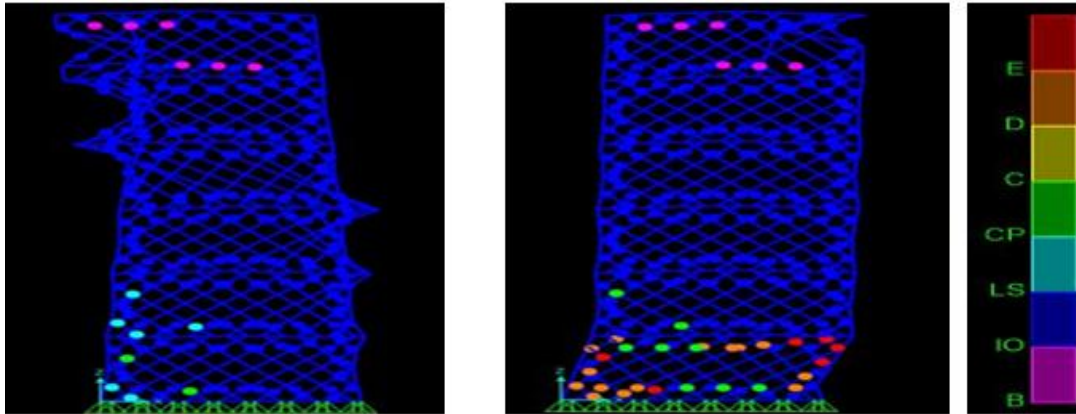

Figure 8. Response of CSPSW (Left) and SPSW (Right) subjected to Cape Mendocino far field input.

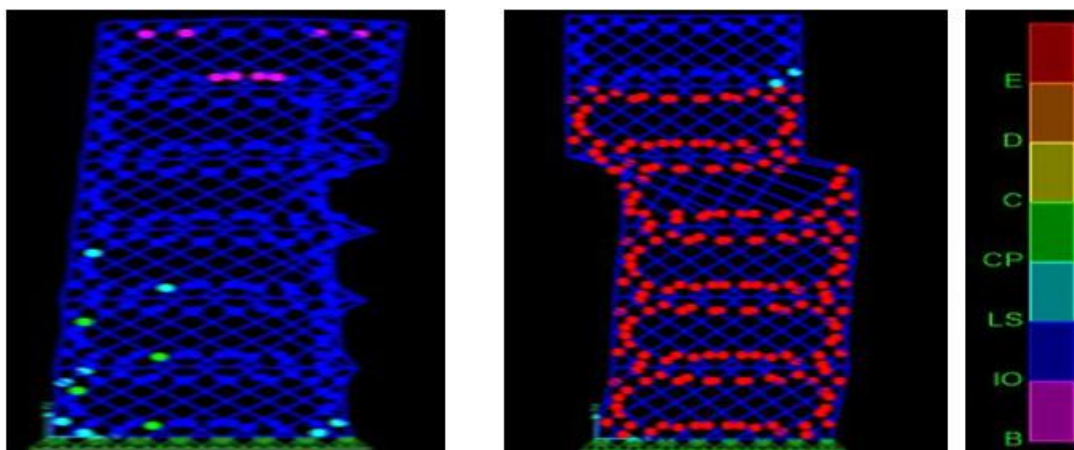

Figure 9. Response of CSPSW (Left) and SPSW (Right) subjected to Tabas near field input.

Moreover, figures 11 and 12 show seismic performances of SPSW and CSPSW subjected to Cape Mendocino far field ground motion at various seismic levels in terms of relative displacements, respectively. The values reported here are controlled according to Standard No. 2800 [9]. Allowable displacement is considered as 0.02 in current work. Seismic behaviour of SPSW and CSPSW subjected to Tabas near field ground motion at various seismic levels in terms of relative displacements are also observed in figures 13 and 14, respectively. As can be seen, CSPSW are able to decrease relative story displacements more than SPSW. Under lower maximum acceleration values of near field records relative displacements of CSPSW become more than allowable code criterion.

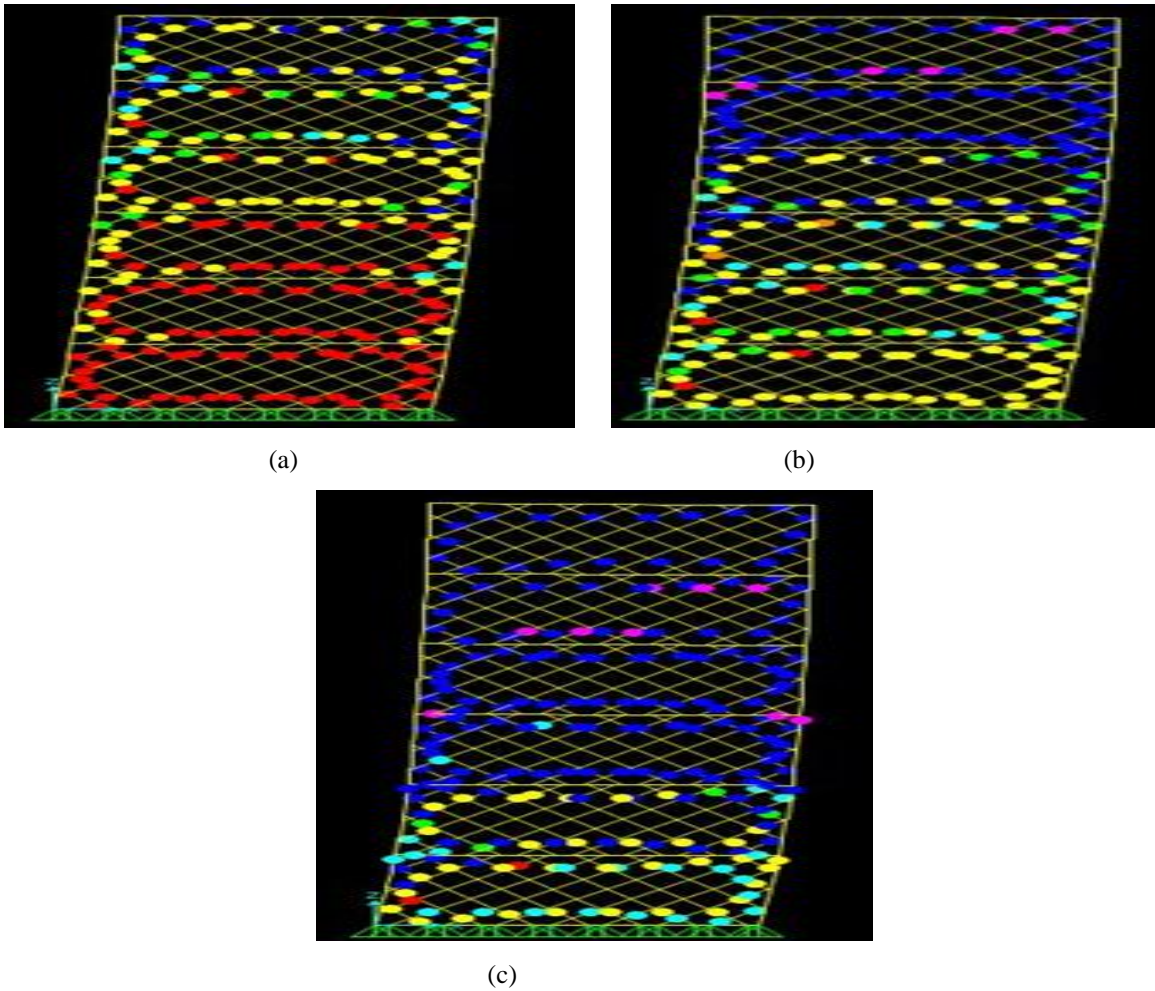

Figure 10. Performance levels of 6 story building under pushover analysis for plastic CSPSW (a), plastic CSPSW and beams (b) and plastic CSPSW, beams and columns (c).

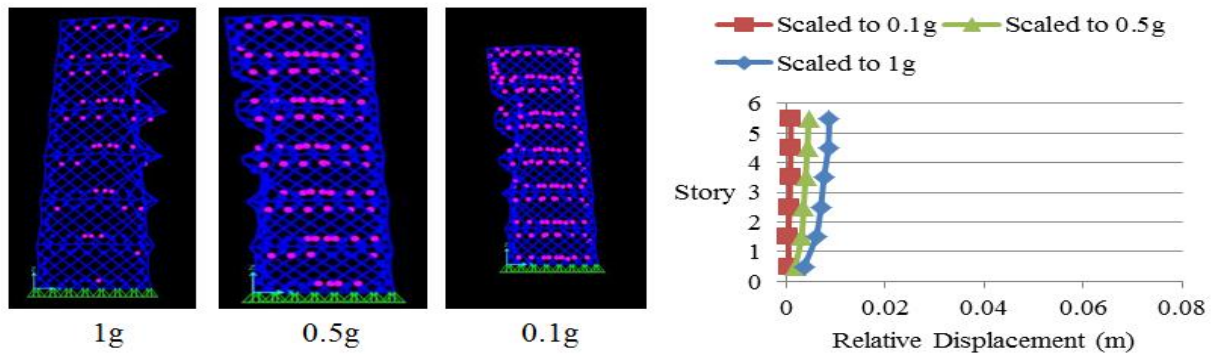

Figure 11. Relative displacement of SPSW subjected to Cape Mendocino earthquake.

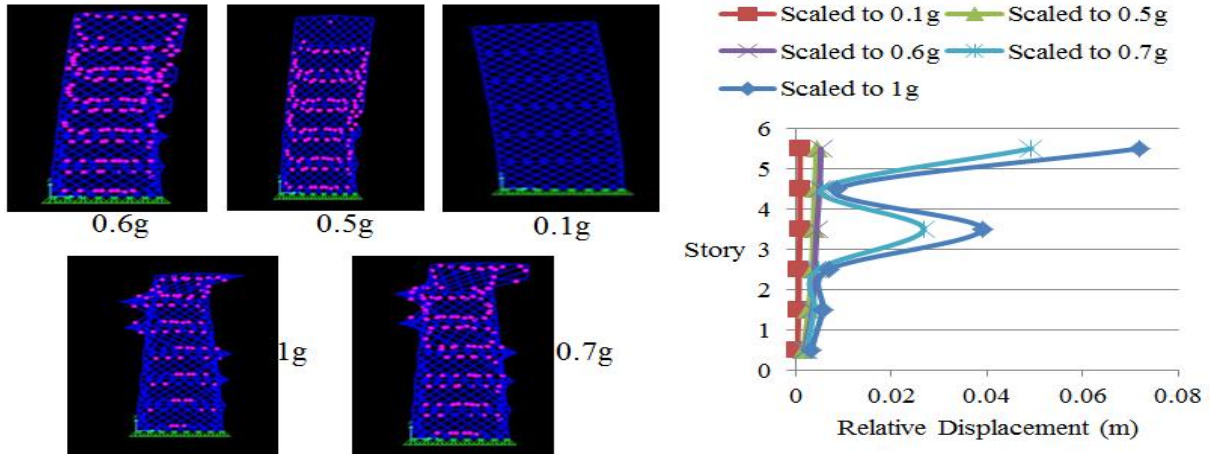

Figure 12. Relative displacement of C-PSW subjected to Cape Mendocino earthquake.

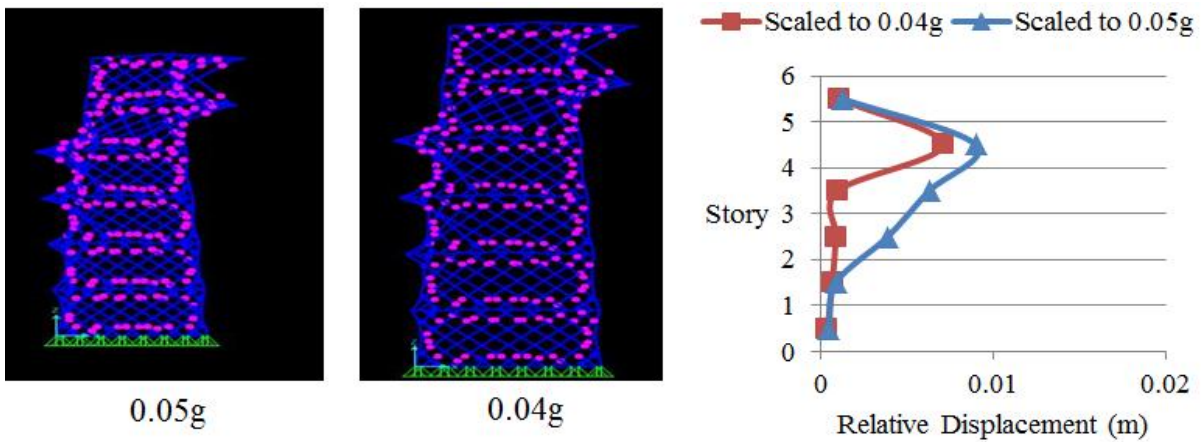

Figure 13. Relative displacement of S-PSW subjected to Tabas earthquake

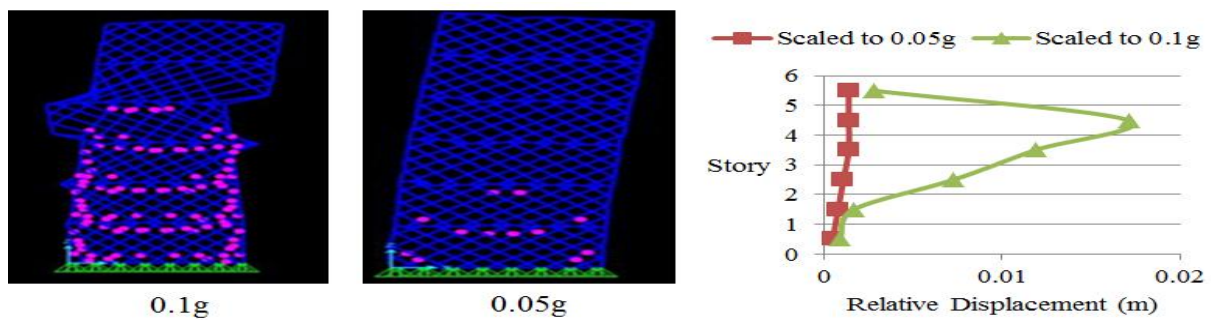

Figure 14. Relative displacement of C-PSW subjected to Tabas earthquake



6. Conclusion

In this work, the seismic performance of CSPSW and SPSW was investigated under different near- and far- field inputs. Strip elements were employed to model the CSPSW and SPSW in SAP2000. An experimental result of CSPSW was first verified. A six story building frame equipped with both systems was then modeled and six different far and near field seismic records were applied to the building frame. Nonlinear Time History Analyses (NTHAs) were conducted based on different maximum ground acceleration levels. Results revealed that appropriate seismic performance of CSPSWs can be clearly observed. CSPSW are able to decrease relative story displacements more than SPSW. More precisely, CSPSWs experience Life Safety (LS) performance level or at least Collapse Prevention (CP) performance level while SPSWs fully collapse. Moment frame collapse intensity contribution was also studied through pushover analyses. It was observed that CSPSW damage decreases with contribution of beams and then columns in nonlinear behavior.

7. References

- [1]- Zhao, Q. and A. Astaneh-Asl., 2004, **Cyclic behavior of traditional and innovative composite shear walls**, Journal of Structural Engineering, 130, 2, 271-284.
- [2]- Tsai, K. C., Lin, Y. C. and Lin, C. H., 2006, **Seismic responses and design of steel plate shear wall**, The Proc. of The fourth Cross-Strait and Hong Kong Conference on Steel Structures, Shanghai, 108-116.
- [3]- Gao H., 2007, **Experimental and Theoretical Studies on Composite Steel Plate Shear Walls**, A dissertation submitted to Tongji University in conformity with the requirements for the degree of Master, Shanghai, China.
- [4]-Thorburn, L. J., Kulak, G. L., and Montgomery, C. J., 2003, **Analysis of steel plate shear walls**, Structural Engineering Report. No. 107, Depart. of Civil Engrg., University of Alberta, Canada.
- [5]-Driver, R. G., Kulak, G. L., Elwi, A. E. and Kennedy, D. J. L., 1998, **FE and simplified models of steel plate shear wall**, ASCE Journal of Structure Engineering 124, 2, 121-30.
- [6]- Taherian, I., Ghalehnovi, M., and Jahangir, H., 2015, **Analytical Study on Composite Steel Plate Walls Using A Modified Strip Model**, In 7th International Conference on seismology and Earthquake Engineering.
- [7]- Berman, J. and Bruneau, M., 2003, **Plastic analysis and design of steel plate shear walls**, Journal of Structural Engineering 129, 11, 1448-1456.
- [8]-AISC, 2005, **Seismic Provisions for Structural Steel Buildings**, AISC, Chicago, USA.
- [9]- Iranian code of practice for resistant design of buildings, 2015, **Iranian code of practice for seismic resistant design of buildings**, BHRC-PN S-253 known as Standard No. 2800. Road, Housing, and Urban Development Research Center, Tehran, Iran.